



Selection: Semi-hermetic Screw Compressors HS

Input Values

Compressor model	HSN7461-70	Operating mode	Economiser
Refrigerant	R404A	Power supply	400V-3-50Hz
Reference temperature	Dew point temp.	Useful superheat	100%
Liq. subc. (in condenser)	0 K	Additional cooling	Automatic
Auto. subcooling	Auto	Max. discharge gas temp.	80,0 °C
Suct. gas superheat	10,00 K		

Result

Q [W]	Cooling capacity	mHP [kg/h]	Mass flow HP
P [kW]	Power input	Qac [kW]	Additional cooling
I [A]	Current	tcu [°C]	Liquid temp.
COP [-]	COP/EER	pm [bar(a)]	ECO pressure
mLP [kg/h]	Mass flow LP	Qsc [kW]	sub cooler capacity (ECO)

tc	to	-15°C	-20°C	-25°C	-30°C	-35°C	-40°C	-45°C	-50°C
30°C	Q [W]	147630	123931	103097	84835	68872	54962	42880	32427
	P [kW]	48,7	46,8	45,0	43,3	41,7	40,0	38,4	36,6
	I [A]	78,7	75,8	73,2	70,7	68,3	65,9	63,5	61,0
	COP [-]	3,03	2,65	2,29	1,96	1,65	1,37	1,12	0,89
	mLP [kg/h]	3692	3058	2506	2029	1618	1267	969	717
	mHP [kg/h]	4259	3647	3097	2602	2158	1761	1406	1090
	Qac [kW]	--	--	--	--	--	1,24	6,37	10,95
	tcu [°C]	15,87	12,45	8,81	4,91	0,74	-3,69	-8,40	-13,38
	pm [bar(a)]	7,25	6,53	5,82	5,12	4,45	3,82	3,22	2,66
Qsc [kW]	21,2	21,8	21,5	20,5	19,00	17,02	14,74	12,24	
40°C	Q [W]	136810	114833	95547	78655	63894	51035	39878	--
	P [kW]	58,8	57,0	55,2	53,4	51,5	49,6	47,7	
	I [A]	93,7	91,0	88,3	85,6	82,9	80,1	77,2	
	COP [-]	2,33	2,02	1,73	1,47	1,24	1,03	0,84	
	mLP [kg/h]	3641	3006	2455	1980	1573	1227	934	
	mHP [kg/h]	4482	3842	3267	2750	2287	1871	1500	
	Qac [kW]	--	--	--	1,65	7,07	12,04	16,50	
	tcu [°C]	21,7	18,18	14,34	10,20	5,73	0,94	-4,17	
	pm [bar(a)]	8,62	7,77	6,92	6,08	5,27	4,48	3,75	
Qsc [kW]	28,5	27,9	26,6	24,8	22,5	19,81	16,91		
50°C	Q [W]	122243	102563	85270	70085	56765	45110	34949	--
	P [kW]	72,0	70,2	68,4	66,5	64,5	62,4	59,9	
	I [A]	114,2	111,3	108,5	105,6	102,5	99,1	95,5	
	COP [-]	1,70	1,46	1,25	1,05	0,88	0,72	0,58	
	mLP [kg/h]	3529	2897	2350	1880	1479	1139	853	
	mHP [kg/h]	4672	4008	3410	2871	2386	1948	1555	
	Qac [kW]	3,77	9,39	14,75	19,75	24,3	28,3	31,5	
	tcu [°C]	28,6	24,9	20,8	16,29	11,38	6,06	0,33	
	pm [bar(a)]	10,48	9,44	8,39	7,34	6,31	5,32	4,39	
Qsc [kW]	34,3	32,8	30,7	28,0	25,0	21,6	18,10		

-- No calculation possible (see message in single point selection)

*According to EN12900 (10K suction gas superheat, liquid subcooling in Economiser with 5K temperature difference)

Application Limits ECO HSN7461-70

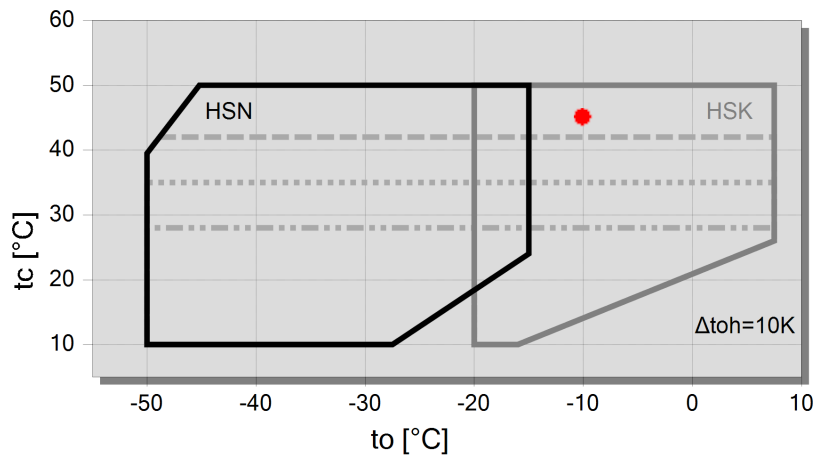

Legend

- max. tc for frequencies = 20Hz
- max. tc for frequencies = 25Hz
- max. tc for frequencies = 35Hz
- A



Technical Data: HSN7461-70

Dimensions and Connections

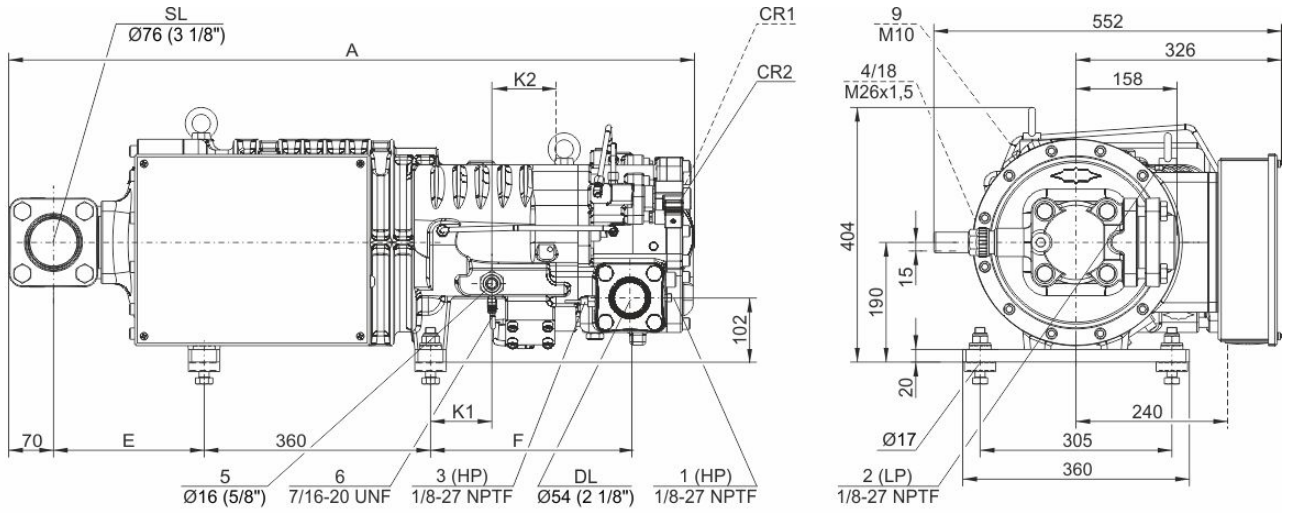

Model	A	E	F	K1	K2
	mm	mm	mm	mm	mm
HS.7451, HS.7461	1021	186	295	76	109
HSK7471-70, HSN7471-75	1034	186	318	98	97
HSK7471-90	1087	238	318	98	97



Technical Data

Technical Data

Displacement (2900 RPM 50 Hz)	220 m ³ /h
Displacement (3500 RPM 60 Hz)	266 m ³ /h
Weight	310 kg
Max. pressure (LP/HP)	19 / 28 bar
Connection suction line	76 mm - 3 1/8"
Connection discharge line	54 mm - 2 1/8"
Adapter/shut-off valve for ECO	22 mm - 7/8" (Option)
Oil type R22	B150SH, B100 (Option)
Oil type R134a/R404A/R507A/R407A/R407F	BSE170
Oil type R448A/R449A/R454C	BSE170

Motor data

Motor version	1
Motor voltage (more on request)	380-415V PW-3-50Hz
Max operating current	124.0 A
Starting current (Rotor locked)	290.0 A D / 485.0 A DD
Max. Power input	75,0 kW

Extent of delivery (Standard)

Discharge gas temperature sensor	Standard
Start unloading	Standard
Oil flow control	SE-B3 (Standard)
Motor protection	SE-E1 (Standard), SE-E3 (Standard for 660-690V)
Suction shut-off valve	Standard
Capacity control	100-75-50% (Standard)
Enclosure class	IP54

Available Options

Discharge shut-off valve	Option
ECO connection with shut-off valve	Option
Motor protection	SE-i1 (200-690V)

Sound measurement

Sound power level (-35°C / 40°C)	88,5 dB(A)
Sound pressure level @ 1m (-35°C / 40°C)	80,5 dB(A)



Semi-hermetic Screw Compressors HS

HSK = Application for air-conditioning and medium temperature cooling.

HSN = Application for low temperature cooling.

Notes regarding application limits (see "Limits")

- * Ranges are valid for standard operation and at full-load conditions.
- * With high pressure conditions, part-load operation is partly limited (see application limits in applications manual SH-100).
- * With Economizer operation the maximum admissible evaporation temperature is shifted by 10K downward (otherwise there is a danger of excessive compression and overload of the motor because of a higher mass flow). At pull-down conditions from higher evaporation temperatures, the ECO injection must remain closed until the evaporation temperature is below the maximum admissible value and a stable operation is achieved (e.g. control of the ECO solenoid valve by means of a low pressure cut-out). The use of the ECO-system with higher evaporation temperatures requires individual consultation with Bitzer.

HS 64/74

- * Capacity control with ECO operation at the same time is limited to one single regulating step (CR 75%). At CR 50% the ECO injection should be closed.

Data for sound emission

Data are based on 50Hz application (IP-units 60Hz) and R404A.

Sound pressure level: values are based on open air test sites with semi-spherical sound emissions at 1 meter distance. For further information see Technical Information "Sound Data".

Legend of connection positions according to "Dimensions":

- 1 High pressure connection (HP)
Connection for high pressure switch (HP)
- 1a Additional high pressure connection (HP)
Not suitable for pressure switch or pressure transmitter!
- 1b Connection for high pressure transmitter (HP)
- 2 Low pressure connection (LP)
Connection for low pressure switch
- 2a Additional low pressure connection (LP)
- 2b Connection for low pressure transmitter (LP)
- 2c Low pressure connection for the minimum pressure differential control valve
- 3 Connection for discharge gas temperature sensor (HP)
- 4 Connection for economiser (ECO)
HS.85: ECO valve with connection line (option)
OS.85, OS.95, OS.105, HS.95: ECO valve (option)
- 5 Connection/valve for oil injection
- 6 Oil pressure connection
- 7 Oil drain (compressor or motor housing)
- 7a Oil drain (suction gas filter)
- 7b Oil drain from shaft seal (maintenance connection)
- 7c Oil drain hose (shaft seal)
- 8 Threaded bore for foot fastening
- 9 Threaded bore for pipe fixture (ECO and LI lines)
- 10 Maintenance connection for oil filter
- 11 Oil drain (oil filter)
- 13 Oil filter monitoring
- 14 Oil flow switch
- 15 Earth screw for housing
- 16 Pressure blow-off (oil filter chamber)
- 17 Maintenance connection for shaft seal
- 18 Liquid injection (LI)
- 19 Compressor module
- 20 Slider position indicator
- 21 Oil level switch
- 22 Oil pressure transmitter



- 23 Connection for oil and gas return (for systems with flooded evaporator adaptor optional)
- 24 Access to oil circulation restrictor
- 25 Oil inlet for shaft seal cooling
- 26 Oil outlet for shaft seal cooling
- 27 Temperature sensor in the shaft seal
- 28 Vibration sensor connection
- SL Suction gas line
- DL Discharge gas line

Dimensions can show tolerances according to EN ISO 13920-B.